

Bestway®





OWNER'S MANUAL

58390E/58647E Filter Pump



Visit the Bestway YouTube channel

IMPORTANT SAFETY INSTRUCTIONS

Carefully read, understand, and follow all information in this user manual before installing and using the Filter Pump. These warnings, instructions, and safety guidelines address some common risks of water filtration systems, but they cannot cover all risks and dangers in all cases. Always use caution, common sense, and good judgment when enjoying any water activity. Retain this information for future use. In addition, the following information can be supplied depending on the Filter Pump type. Keep the instructions in a safe place. If instruction is missing, search it on the website www.bestwayusa.com/ourwarranties.

When installing and using this electrical equipment, basic safety precautions should always be followed, including the following:

READ AND FOLLOW ALL INSTRUCTIONS

WARNING - TO REDUCE THE RISK OF INJURY, do not permit children to use this product unless they are closely supervised at all times.

WARNING - RISK OF ELECTRIC SHOCK. Connect only to a grounding type receptacle. This product is provided with a ground-fault circuit-interrupter. If replacement of the plug is needed, use only identical replacement parts.

WARNING: The unit is provided with a ground-fault circuit-interrupter (**GFCI**). To test the **GFCI**, push the test button. The **GFCI** should interrupt power. Push the reset button. Power should be restored. If the **GFCI** fails to operate in this manner, the **GFCI** is defective. If the **GFCI** interrupts power to the pump without the test button being pushed, a ground current is flowing, indicating the possibility of an electric shock. Do not use this pump. Disconnect the pump and have the problem corrected by a qualified service representative before using.

CAUTION - To reduce the risk of electric shock the pool must be installed no closer than 6 feet (1.8 m) from any electrical outlet. Do not place portable appliances closer than 5 feet (1.5 m) from the pool.

WARNING: The pump is not intended to be bonded to the equipotential bonding grid. **DO NOT BURY CORD**. Locate cord to minimize abuse from lawn mowers, hedge trimmers, and other equipment.

WARNING - To reduce the risk of electric shock, **IF FILTER PUMP POWER CORD BECOMES DAMAGED IN ANY WAY, THE PUMP MUST BE DISCARDED.**

WARNING - To reduce the risk of electric shock, do not use extension cord to connect unit to electric supply; provide a properly located outlet.

CAUTION - This pump is for use with storable pools only. Do not use with permanently-installed pools. A storable pool is constructed so that it is capable of being readily disassembled for storage and reassembled to its original integrity. A permanently-installed pool is constructed in or on the ground or in a building such that it cannot be readily disassembled for storage.

CAUTION - For continued protection against possible electric shock this unit is to be mounted to the base in accordance with the installation instructions.

NOTE:

- THERMALLY PROTECTED MOTOR.
- FOR USE WITH SWIMMING POOLS ONLY.

CAUTION: TO ENSURE CONTINUED PROTECTION AGAINST SHOCK HAZARD, USE ONLY IDENTICAL REPLACEMENT PARTS WHEN SERVICING.

WARNING: RISK OF ELECTRIC SHOCK. CONNECT ONLY TO A GROUNDING TYPE RECEPTACLE.

CAUTION: THIS PUMP IS FOR USE WITH STORABLE POOLS ONLY - DO NOT USE WITH PERMANENTLY-INSTALLED POOLS.

CAUTION: CONNECT ONLY TO GROUNDING TYPE RECEPTACLE PROTECTED BY A CLASS A GROUND FAULT CIRCUIT INTERRUPTER.

CAUTION: FOR CONTINUED PROTECTION AGAINST POSSIBLE ELECTRIC SHOCK THIS UNIT IS TO BE MOUNTED TO THE BASE IN ACCORDANCE WITH THE INSTALLATION INSTRUCTIONS.

WARNING - RISK OF ELECTROCUTION

- Connect Only To Properly Grounded Outlet. Do Not Remove Ground Pin.
- Inspect Cord Before Using – Do Not Use If Cord Is Damaged.
- Keep Ground-Fault Circuit-Interrupter Dry And Off The Ground.
- Do Not Touch Plug With Wet Hands.
- Double Insulated – When Servicing Use Only Identical Replacement Parts.
- Read Instruction Manual Before Using.

DO NOT REMOVE THIS TAG

SAVE THESE INSTRUCTIONS.

This device complies with part 15 of the FCC Rules. Operation is subject to the following two conditions: (1) This device may not cause harmful interference, and (2) this device must accept any interference received, including interference that may cause undesired operation.

WARNING: Any changes or modifications to this unit not expressly approved by the party responsible for compliance could void the user's authority to operate the equipment.

NOTE: This equipment has been tested and found to comply with the limits for a Class B digital device, pursuant to part 15 of the FCC Rules. These limits are designed to provide reasonable protection against harmful interference in a residential installation. This equipment generates, uses and can radiate radio frequency energy and, if not installed and used in accordance with the instructions, may cause harmful interference to radio communications. However, there is no guarantee that interference will not occur in a particular installation. If this equipment does cause harmful interference to radio or television reception, which can be determined by turning the equipment off and on, the user is encouraged to try to correct the interference by one or more of the following measures:

- Reorient or relocate the receiving antenna.
- Increase the separation between the equipment and receiver.
- Connect the equipment into an outlet on a circuit different from that to which the receiver is connected.
- Consult the dealer or an experienced radio/TV technician for help.

POOL SUCTION FITTING INSTRUCTIONS

When installing and using this equipment, basic safety precautions shall always be followed, including the following:

IMPORTANT SAFETY INSTRUCTIONS READ, FOLLOW, AND UNDERSTAND ALL INSTRUCTIONS AND WARNINGS.

- Any modification that increases the flow rate of the circulation system shall require re-evaluation of the cover/grate and sump to ensure that the flow rating of the Suction Outlet Fitting Assembly (SOFA) is not exceeded.
- Missing, broken, or cracked cover/grates, sumps, mud-frames, or any other SOFA component shall be replaced before bathers are allowed to use the pool.
- Loose cover/grates shall be reattached before bathers are allowed to use the pool.
- Replace suction fittings every 2 years.
- The use of adhesives or other attachment methods that prevent access to suction piping or SOFA components requiring periodic servicing is prohibited.
- Refer to the following diagram for each SOFA component part instructions:
 - Any field modification made to a SOFA not authorized by the manufacturer's installation instructions shall void the SOFA certification.
 - No modification shall be made to a SOFA structure or flow path unless the new configuration has been certified as new SOFA.
 - Cover/grates and all other SOFA components shall be replaced at or before the end of their service life and that service life begins the month and year in which a SOFA component is installed with or without water.
- Winterizing instructions. Dry the suction fittings completely, and store the product in a dry room at a storage temperature of 10°C ~ 38°C.
- Use the screwdriver (not included) to disassemble the suction fitting to clean or service.
- Cover/grate, including fasteners, shall be observed for damage or tampering each operational day.
- Missing, broken, or cracked cover/grates shall be replaced before bathers are allowed to use the pool.

- Loose cover/grates and associated components shall be reattached before bathers are allowed to use the pool.
- SOFA components and fastener receptacles shall be clean and free of debris or obstructions during installation of cover/grate and fasteners.
- Remember to hand-check cover/grate for snugness to the sump/frame after installation.
- Before using the product, please check the integrity of the head of the suction fitting. If the product is broken, cracked, or the color has significantly faded, please do not use it.
- All SOFAs shall be installed in accordance with the manufacturer's installation instructions.
- No modification shall be made to a SOFA structure or flow path unless the new configuration has been certified to the original SOFA.
- These SOFA-configuration specific flow ratings NOT be exceeded at any time the pool is open to bathers.
- Cover/grates, when installed, shall not protrude more than 2 in. (51 mm) from the finished surface of the pool in which the SOFA is installed.

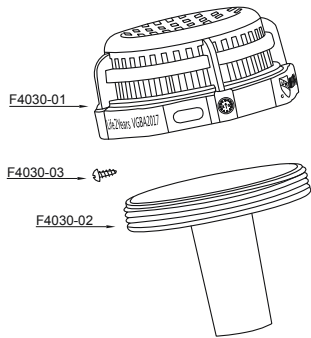

Installation Information label (copy)

Manufacturers name:

GOLEADER INDUSTRIES (JINHUA) CO., LTD.

Cover part number: F4030

Service life of the cover: 2 Years

Cover flow rating: 28 GPM

Installer needs to fill in the balance of the information and permanently post it as near as feasible to the pump control.

Keep a copy of this information with the other important pool related documents.

Configuration and installed orientation: _____

Location: _____

Installed Date: _____

Please research and download General Certificate of Conformity through www.bestwayusa.com

SAVE THESE INSTRUCTIONS

TECHNICAL SAFETY INSTRUCTIONS

- Using the pump with an unmatched electrical supply is dangerous and will result in catastrophic failure of pump.
- Risk of electric shock - When working with electricity, turn the electrical power off at the circuit breaker and lock breaker door. Failure to do so will result in increased risk of shock, injury and possibly death.
- Do not remove the grounding prong or modify the plug in any way. Do not use adapter plugs. Consult a qualified electrician for any questions related to the validity of your plug's grounding. Handle the pump with care. Do not pull or carry the pump by the power cord. Never pull a plug from the outlet by yanking the power cord. Keep cord free from abrasions. Sharp objects, oil, moving parts, and heat should never be exposed to the filter pump.
- Atmospheric conditions may affect the performance and life span of your filter pump. Unnecessary wear and tear may occur during periods of cold, heat and exposure to sun. Whenever possible shelter the pump from these conditions.
- Do not add chemicals in the filter pump.
- Assembly and disassembly of this product should only be performed by adults.

GFCI WARNING

- Risk of electric shock. The GFCI must be tested before each use.
- Before inserting plug into a power outlet, make sure the current rate of the power outlet is suitable for the pump.
- Do not use the pump if this test fails. For assistance, please visit the support section on our website, www.bestwayusa.com.
- To prevent the risk of electrical shock, ensure your hands are completely dry when plugging-in the Filter Pump.
- Do not dry run the filter pump. Make sure both the pool's Inlet and Outlet valves are fully covered by water before operating the Filter Pump.

ATTACHING A BASE

The filter pump must be vertically fixed on the ground or a base made of wood or concrete before use. There should be two holes 9mm in diameter on the base, the space between which should be 163mm. Put filter pump on the base and attach them together by fastening the bolts and nuts. All the base parts should weigh at least over 18kg to prevent the pump from accidentally falling.

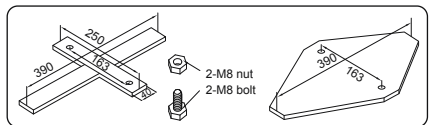

SETUP

CHECK LIST

To check the parts included in the box, consult the part list inside this manual. Verify that the equipment components represent the model that you had intended to purchase. In case of any damaged or missing parts at the time of purchase, visit our website bestwayusa.com/ourwarranties.

CHOOSE THE CORRECT LOCATION

Place the Filter Pump on a solid and level ground; it must be positioned on the same level as the base of the pool. If the Filter Pump is in an upper or lower position than the base of the pool, the performance and life span of the Filter Pump can be compromised. The pool and the Filter Pump have to be positioned in an area with adequate drainage and easy access for maintenance operations. Never place the Filter Pump in a area that may accumulate water.

INSTALLATION

- For the installation instructions, refer to the illustration steps  inside the manual. Drawings are for illustration purposes only. May not reflect actual product. Not to scale.
- Bestway will not be responsible for any damage caused to the Filter Pump due to mishandling or failure to follow these instructions.
- It is imperative to check that the hydraulic connectors are not obstructed.
- Do not dry run the Filter Pump. Make sure both the pool's inlet and outlet valves are fully covered by water before operating the Filter Pump.

GFCI TEST

Each LED indicator represents 2 hours of working time. You can push the Set Working Hours Button to adjust the desired time.

- After setting the run time, the pump will restart automatically at the same time the following day.
- In case of a power outage or the GFCI being unplugged, the running time of the product will be reset to a 10 hour default and the previous set will be deleted.
- After finishing the working time, the GFCI goes into stand-by mode. During this time, all LED indicators will be off.
- Pushing the test button on the GFCI does not stop the timer. To stop the timer, you have to unplug the GFCI.

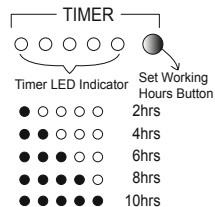

MAINTENANCE

- Make sure that the Filter Pump is unplugged before any maintenance.
- For the maintenance instructions, refer to illustration steps  inside the manual. Drawings are for illustration purposes only. May not reflect actual product. Not to scale.
- To optimize the Filter Pump performance and for sanitary reasons, we suggest replacing the filter cartridge with a new one every two weeks.

STORAGE

- Remove all accessories; be sure that Filter Pump, hoses and debris screens are completely clean and dry before the storage. If all the parts are not completely dry, mold may result.
- Before storage, remove and dispose of the filter cartridge.
- We strongly recommend disassembling the Filter Pump when the environment temperature is below 50°F / 10°C.
- Store the Filter Pump in a dry place with a moderate temperature between 50°F / 10°C and 100°F / 38°C.

WARRANTY TERMS

For information concerning warranty terms, visit our website at: www.bestwayusa.com



	V1	V2
1	x1	x1
2	x1	x1
3	x1	x1
4	x1	x1
5	x1	x1
6	x3	x3
7	x2	x2
8	x2	x2
9	x0	x2
10	x4	x5
11	x1	x1
12	x2	x2
13	x2	x2
14	x0	x1

V1

V2



V1

1.1

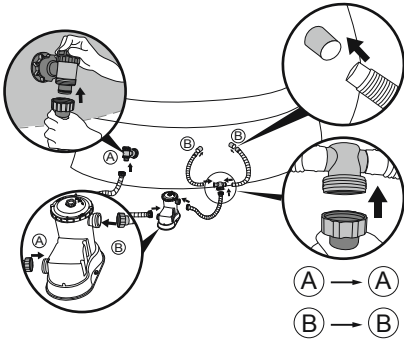

1.2

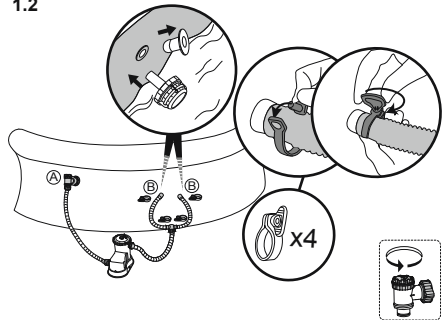

1.3

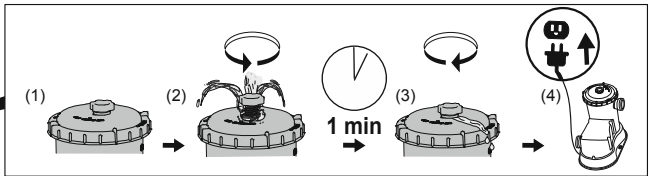
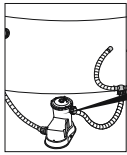

2.1

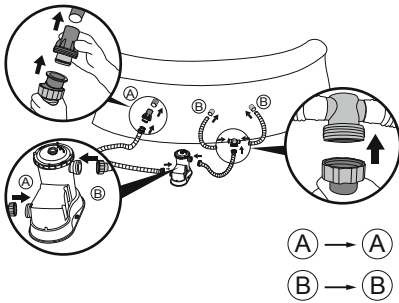

2.2

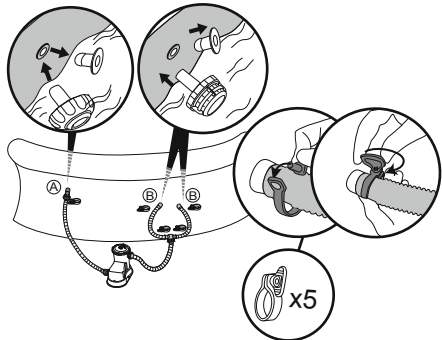

2.3

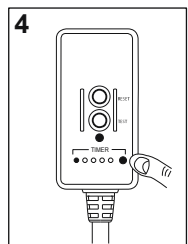
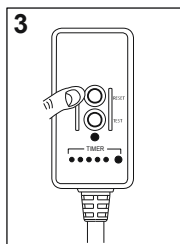
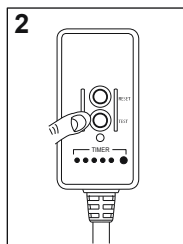
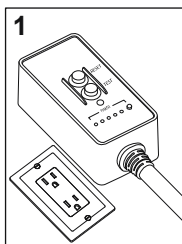
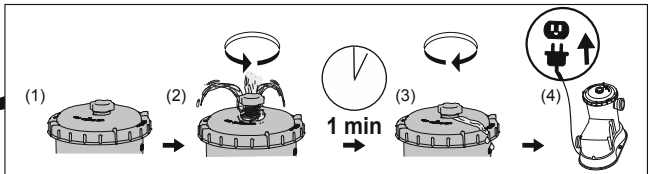
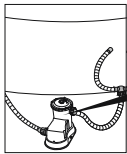



V1

1.1

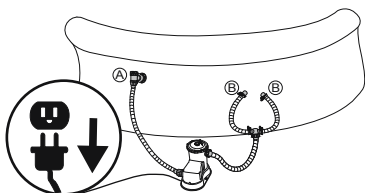

1.2

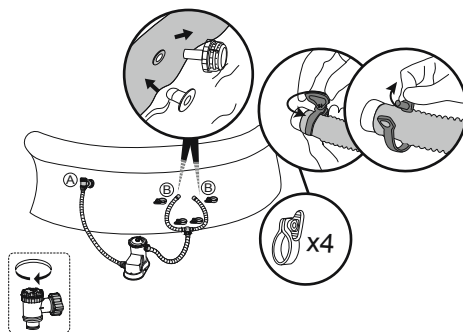

1.3

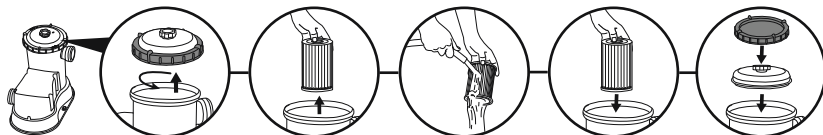

1.4

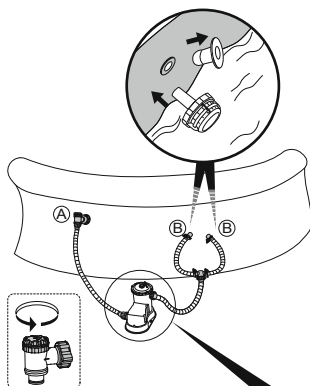

(1)

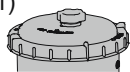

(2)

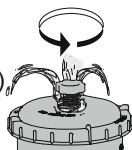

1 min

(3)

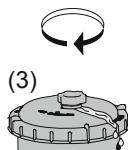

(4)

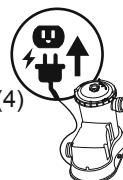



V2

2.1

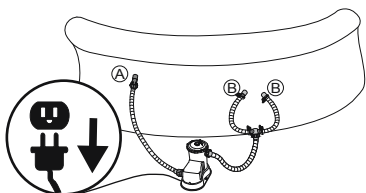

2.2

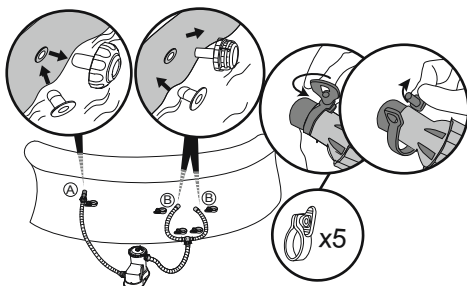

2.3

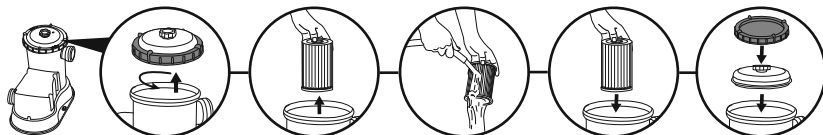

2.4

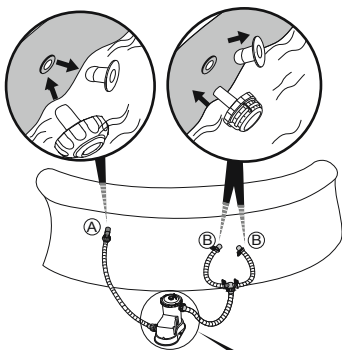

(1)

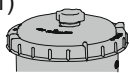

(2)

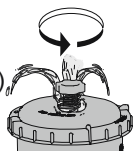

1 min

(3)

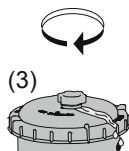

(4)

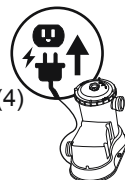



For support please visit us at:
[bestwayusa.com/ourwarranties](https://www.bestwayusa.com/ourwarranties)

©2023 Bestway Inflatables & Material Corp.

All rights reserved

Trademarks used in some countries under license from **Bestway Inflatables & Material Corp., Shanghai, China**

Exported by **Bestway (Hong Kong) International Ltd./Bestway Enterprise Company Limited**

Suite 713, 7/Floor, East Wing, Tsim Sha Tsui Centre, 66 Mody Road, Kowloon, Hong Kong

Distributed in North America by **Bestway (USA) Inc., 3435 S. McQueen Road, Chandler, AZ 85286, United States of America**

Tel: +86 21 69135588

www.bestwayusa.com