



---

SKU# 358015W, 359015G, 360018W, 361018G

# FRAME SWIMMING POOL PACKAGES WITH COVER

## INSTRUCTION MANUAL

15-FT Round, 48-IN Deep

18-FT Round, 52-IN Deep

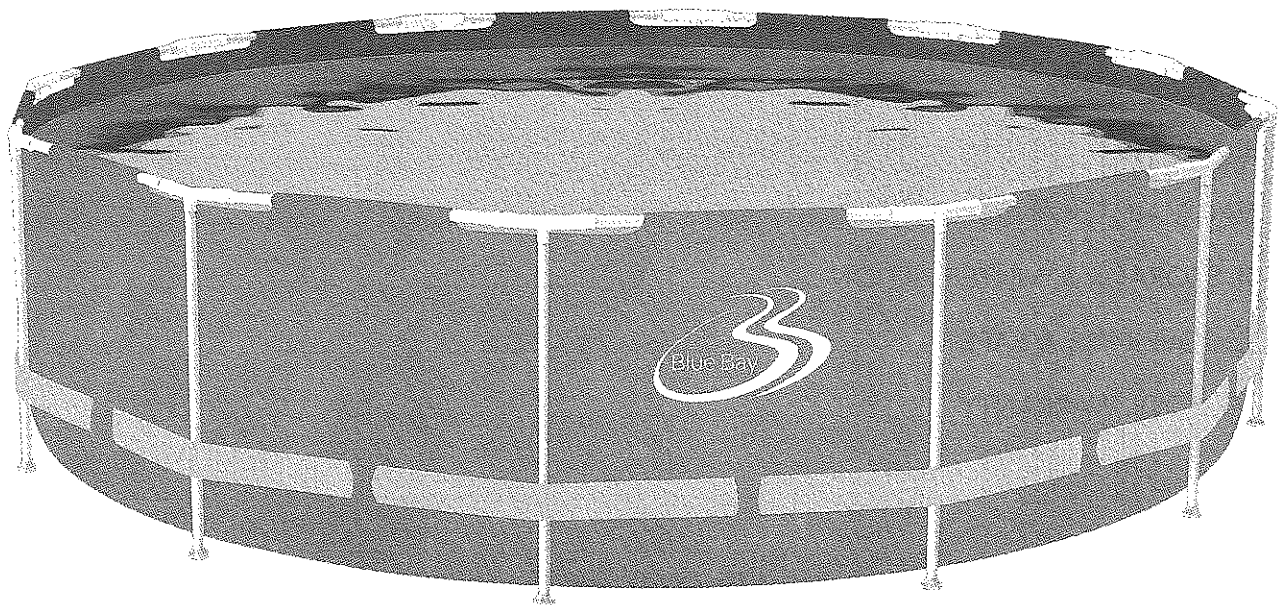

# TABLE OF CONTENTS

THANK YOU! .....	3
SAFETY INFORMATION .....	3
SAFETY INSTRUCTIONS .....	3
GENERAL WATER SAFETY .....	4
ADDITIONAL POOL AND WATER SAFETY GUIDELINES .....	5
PARTS DIAGRAM .....	6
PARTS LIST .....	7
SELECTING A SUITABLE SITE .....	8
POOL SETUP .....	9
LEVELING THE AREA .....	10
POOL ASSEMBLY INSTRUCTIONS .....	11
POOL LADDER ASSEMBLY .....	11
FILTRATION SYSTEM, WATER INTAKE, & RETURN FITTING INSTALLATION .....	14
FILLING THE POOL WITH WATER .....	14
SAFETY WARNINGS .....	15
POOL MAINTENANCE & DRAINING .....	16
JET VAC MAINTENANCE KIT .....	17
POOL STORAGE & WINTERIZATION .....	17
POOL COVER USE & SAFETY .....	18
FRAME POOL WARRANTY .....	19

# THANK YOU!

Thank you for purchasing this product. We work around the clock and around the globe to ensure that our products maintain the highest possible quality.

Please read the warranty information at the back of these assembly instructions for further details.

## ⚠ SAFETY INFORMATION

Please read this entire manual before attempting to assemble, operate, or install the product.

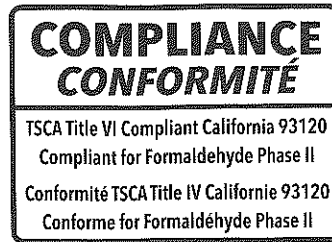
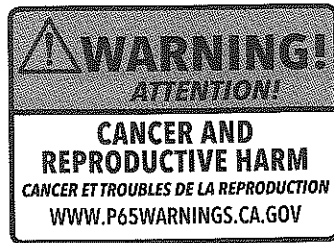

## SAFETY INSTRUCTIONS

Please examine equipment before use. If there are any damaged or missing parts at the time of purchase, do not assemble or operate until parts are replaced.

To lessen the risk of serious injury or death, follow these rules.

The following instructions contain important safety information, please read these important safety instructions and abide by them when installing and using this pool. When installing and using the electrical equipment, basic safety precautions must always be followed.

This includes the following:

### WARNING!

Children have drowned in swimming pools.

Ensure active adult supervision at all times. Do not leave children unsupervised in or around the pool. Keep them within arms reach.

**WARNING:** Consult local municipality, water authority, and building codes in regard to the use of water and/or water restrictions relating to this product.

**WARNING:** Pool fencing laws affect this product, consult the local municipality for applicable building codes. Abide by state and federal law requirements such as fencing, enclosures, childproof gates, etc. as found in CPSC Pub. No. 362

**WARNING:** Always remove pool ladder when not in use. Store in a place where it is not accessible to children.

**DANGER:** Prevent the risk of accidental drowning. Extreme caution must be exercised to prevent unsupervised access by children. To avoid accidents, ensure that children cannot use the pool unless they are always supervised by an adult. NEVER LEAVE CHILDREN UNATTENDED.

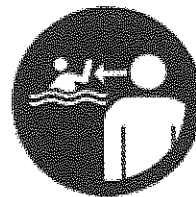

## SAFETY INSTRUCTIONS (CONTINUED)

**RISK OF ELECTRIC SHOCK:** Connect filter pump only to a grounding type receptacle protected by a GFCI (Ground Fault Circuit Interrupter). Use a qualified electrician to install the GFCI, which has a maximum rate of 30A.

**WARNING:** Always know where the cut-off switch for the pump is, so it can be turned off in an emergency. It is necessary to have the GFCI Cut-Off Switch plug accessible after installation of the pool.

**WARNING:** To avoid electrocution, do not permit electric devices i.e., electric lights, telephone, radio, television, hair dryer, etc. within 8-ft of this pool.

**WARNING:** Do not touch the filter pump unless the area around it is completely dry.

**WARNING: NEVER** allow horseplay, diving, or jumping into or around a softside frame pool.

**WARNING: NEVER** enter the pool via any decks or other raised surface, the water level of the pool is shallow. Serious injury, paralysis, or death could result.

**CAUTION:** It is advisable to wear protective gloves when assembling pool.

**WARNING:** Follow all safety and installation instructions provided with the filtration system, ladder, and accessories

## GENERAL WATER SAFETY

- **ALWAYS** supervise children around water.
- Ensure a pool fence is correctly installed and functioning if it is required by your local municipality or state code.
- Follow all local and National Pool Safety Codes.
- Learn CPR and keep in practice.
- Post emergency phone numbers near a phone and the pool.
- Teach your children to swim as early as possible.
- Keep any object that could be used by a child to climb into the pool at least 4-ft away from the side of the pool.
- Read these safety instructions to your children often.
- Prepare yourself mentally for any situation that may occur. You may be required to offer adequate aid and assistance.
- Many swimming pool and water safety publications are available online. You are urged to review them and share with all members of your family.



**NO DIVING**



**NO JUMPING**



**NO SLOPING GROUND**



**USE ONLY UNDER  
COMPETENT SUPERVISION**

## **ADDITIONAL POOL AND WATER SAFETY GUIDELINES**

- Name a safety supervisor before people enter the swimming pool area. Reinforce supervision when there are several people in or around the swimming pool.
- Have personal flotation aids available.
- Wet your neck, arms, and legs before entering the water.
- Make sure you are trained in life-saving techniques, especially those for children.
- Forbid anyone from diving or jumping into the pool.
- Forbid races and rough play in the pool.
- Do not allow children who are unable to swim to enter the pool without a swim vest, approved life jacket, or adult supervision. Flotation devices are not a substitute for adult supervision.
- Do not leave toys near or in the pool without supervision.
- Always keep the water clear and sanitized.
- Store the water treatment products away from children's reach.
- Always keep a pool buoy and pool pole at the pool side.
- Keep the pool fence gate shut when the pool is not occupied.
- If possible, use an electronic pool alarm that can detect someone falling into a pool.
- Install all warning and danger decals and signs as instructed.
- Contact the dealer or retailer for additional signs if deemed necessary.
- A barrier is necessary to provide protection against potential drowning. The barriers are not a substitute for the constant supervision of children.
- Publications are available that describe the risk of drowning, entrapment, and diving accidents. Available publications related to pool safety include the Association of Pool and Spa Professionals' (APSP) booklets entitled: The Sensible Way to Enjoy Your Aboveground/Onground Swimming Pool, Children Aren't Waterproof, Pool and Spa Emergency Procedures for Infants and Children, Layers of Protection, and the latest published edition of ANSI/APSP-8 Model Barrier Code for Residential Swimming Pools, Spas, and Hot Tubs.
- Basic lifesaving equipment, including one of the following, must be on hand at all times: a light, strong, rigid pole no less than 12-ft (3.66-m) long OR a rope that has a minimum diameter of 1/4-in (6-mm) and is 1.5 times longer than the total width of the pool or is 50-ft (15.24-m) long. Firmly attach either the rope or the pole to a Coast Guard-approved ring buoy or a similarly approved flotation device.
- Use artificial lighting during nighttime pool use, to illuminate all safety signs, ladders, steps, deck surfaces, and walks.
- The bottom of the pool must be visible at all times from the outside perimeter of the pool.
- Homeowners must maintain water clarity so that the deepest part of the pool is visible.
- Installers are responsible for the following requirements during pool installation:

## **ADDITIONAL POOL & WATER SAFETY GUIDELINES**











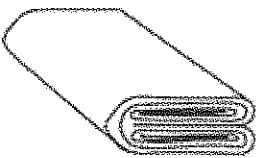
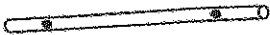

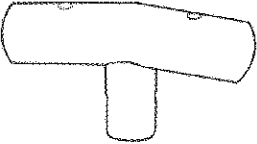

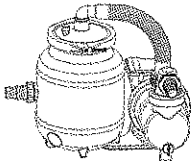
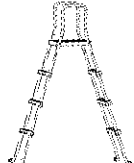
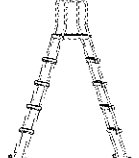

- a) Installers must follow written instructions regarding positioning of all equipment connected to the circulation systems. All of these components must be positioned to prevent access to the pool by young children. (See the latest published edition of ANSI/APSP-8 Model Barrier Code for Residential Swimming Pools, Spas, and Hot Tubs.)
- b) The installer must follow written instruction provided for operation of the circulation system components.
- c) The installer must affix safety signs above the water line according to the manufacturer's instructions.
- d) There must not be any protrusions or other obstructions in the swimming area that may cause entrapment or entanglement of the user.
- e) The ladder must be located on a solid base and installed per the manufacturer's instructions.
- f) The installer must follow regulations on setback, barriers, devices, and other conditions.
- g) The installer must ensure that all pools and their related components that are installed in an indoor environment shall comply with the ventilation requirements of ANSI/ASHRAE 62.
- h) Installers must locate the pool in accordance with the manufacturer's instructions.

**THERE IS NO REPLACEMENT FOR CLOSE ADULT SUPERVISION OF CHILDREN**

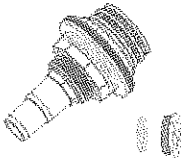
**SAVE THESE INSTRUCTIONS**

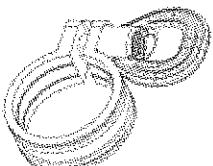
# PARTS DIAGRAM

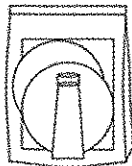
Contents vary by package and depth. See the Parts Chart on the next page for specific detail of what is in your package. Check all parts and ensure they are present and undamaged before assembly. Images and objects may differ. Report missing or damaged parts immediately to have them replaced.

Parts Diagrams - Frame Pool			
			
1. Pool Liner	2. Horizontal Beam	3. Vertical Leg	4. Horizontal Connecting T
			
5. Leg Cap	6. Pin & Grommet Sets	7. Drain Connector	8. Water Stop
			
9. Pool Cover	10.1 EZ Clean 100 Cartridge Filtration System	10.2 EZ Clean 200 Cartridge Filtration System	11.1 A-Frame Ladder for 48" Pool
			
11.2 A-Frame Ladder for 52" Pool	12. Maintenance Kit	13. Water Intake Fitting w/ Water Plug	14. Water Return Fitting for 15' and 18' Pool
			
15. 1.25" Connection Hose	16.1 Hose Clamps for 15' Pool	16.2 Hose Clamps for 18' and 24' Pool	17. Repair Patch
			
18. Drain Cap			

**NOTE:** These part images are NOT to scale. For reference only.

# PARTS LIST

#	BB No.	Parts Description	MFG No.	QTY. 15-FT Round	QTY. 18-FT Round
1	230001	POOL LINER - 15FT	O605015D	1	
	230005	POOL LINER - 18FT	O655218D		1
2	230002	HORIZONTAL BEAMS - 15FT	3810110W	12	
	230006	HORIZONTAL BEAMS - 18FT	3810101W		16
3	230003	VERTICAL LEGS - 15FT	3210117W	12	
	230007	VERTICAL LEGS - 18FT	3212127W		16
4	230004	HORIZONTAL CONNECTING T'S	4236191215W	12	
	230008	HORIZONTAL CONNECTING T'S	4236191218W		16
5	230009	VERTICAL LEG CAPS	V1009C	12	16
6	230010	PIN & GROMMET SETS	P1009C	36	48
7	230011	DRAIN CONNECTOR	835	1	1
8	230012	WATER STOP	L1023B	2	2
9	230013	POOL COVER - 15FT	PEC7015	1	
	230016	POOL COVER - 18FT	PEC7018		1
10	230014	EZ Clean Filter System 100	EZ100X	1	
	230017	EZ Clean Filter System 200	200AQX250W-32		1
11	230015	48" LADDER (Pole & Skimmer Included)	1223T	1	
	230018	52" LADDER (Pole & Skimmer Included)	1324T		1
12	230020	MAINTENANCE KIT	JVSP360	1	1
13	230021	1.25" & 1.5" WATER INTAKE FITTING KIT w/ WATER PLUG (Included with EZ Clean)	91195	1	1
14	230022	1.25" WATER RETURN FITTING KIT (Included with EZ Clean)	91194	1	1
15	230023	1.25" CONNECTION HOSE	321500		2
16	230024	HOSE CLAMPS FOR 15FT (IN FILTER SYSTEM PACKAGE)	104A	4	-
	230019	HOSE CLAMPS FOR 18FT & 24FT (IN FILTER SYSTEM PACKAGE)	309A	-	4
17	230025	REPAIR PATCH	RP1023	1	1
18	230026	DRAIN CAP (PRE-INSTALLED ON VALVE)	D1024	1	1

## SELECTING A SUITABLE SITE

Carefully select the site for your new pool. This is the most important decision to ensure the safety and success of your pool's installation. An incorrect site could cause problems in the future that may result in injury, death, or financial loss. Carefully read the check list below when selecting your site.

### ACCEPTABLE:

- Flat, level, firm, and dry ground
- Easy access to all sides of the pool
- Position in a spot with the most direct sunlight possible
- Ensure safe access to electricity for running the filter pump and other pool accessories
- Easy access to a water source
- Protection from wind, if possible
- A site for easily watching children
- Pump openings are 10 to 20 feet away from the electrical outlet

### NOT ACCEPTABLE:

- Sloping ground
- Concrete, asphalt, sandy gravel, and swampy ground
- Close to wooden construction e.g., pergolas and decking
- On a wooden deck or any wooden surface
- Next to deciduous or leafy trees
- Under wires or clothesline
- Over drains, electric wires, or gas pipelines
- Areas with poor or little drainage
- Near sprinklers or over underground sprinkler plumbing
- High wind areas
- Ground with sharp objects or nut grass that could puncture the pool liner
- Within 15-ft of a house, building, etc.

### TOOLS AND MATERIALS REQUIRED:

- Philips head screwdriver
- Flat blade screwdriver
- Sand sifter
- Sharp stake
- 4-ft Carpenter's Level
- 10-ft long, 2-in x 4-in board
- Sharp knife
- Site excavation tools
- Protective gloves

### ADDITIONAL SITE PREPARATION:

1. The pool shall be located a minimum distance of 6-ft (1.83m) from any electrical receptacle.
2. All 125 volt, 15 and 20 ampere receptacles located within 20-ft (6.0m) of the pool shall be protected by a ground fault circuit interrupter (GFCI). The 20-ft (6.0m) distance is measured via the shortest straight line the supply cord follows without piercing a floor, wall, ceiling, doorway, window, or other permanent barrier.
3. Contact your local utilities, checking that no underground cables, telephone lines, gas lines, etc. run beneath the area you have selected.



is the most important step in the installation of the pool. Do not dig up underground power lines, sewer lines, or other structures. Do not dig up other hard surfaces.

Drive a stake in the center of the area where the pool will be installed. Measure with a string and mark off the pool perimeter using flour, chalk, or a string inside the pool area to 1-ft (30-cm) beyond the dimensions of the pool.

If the installation has Nut Grass, Bermuda Grass, or any other type of grass, it is recommended that a topical grass herbicide is applied. Wait at least 48 hours before installation.

Clear the dirt to remove any small rocks, stones, roots, sticks, or other debris near the pool liner.

A sand or gravel pad (not included) under the pool is recommended. This will help level the ground to the pool liner. Refer to the diagrams below when ordering your pool.

See the references to marking off your pool area. If you bought a 15-ft pool, refer to Diagram 1. If you bought an 18-ft pool, refer to Diagrams 2 and 3.

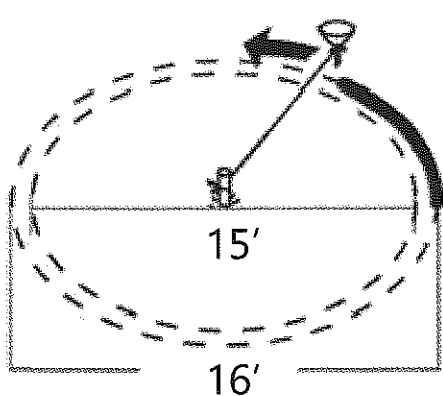

(Diagram 2)

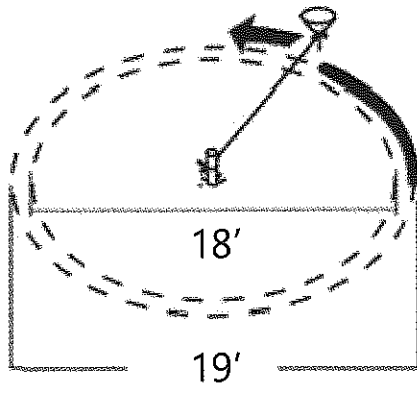

(Diagram 3)

# LEVELING THE AREA

## WARNING!

Leveling is extremely important: Take as much time as necessary to ensure the pool site is completely firm and leveled.

- **WARNING:** VERY IMPORTANT! SITE MUST BE LEVEL, STABLE, COMPACTED SOIL.
- **CAUTION:** You cannot use sand or uncompacted soil to provide a level surface for this pool; it will only wash out.
- **WARNING:** This pool contains thousands of gallons of water! Should the pool collapse due to unlevelled ground, it could cause significant property damage and even result in injury or death.
- Use a carpenter's level and straight edge 10-ft long, 2-in x 4-in board to ensure that the site is completely level! (See diagram 4)
- Remove the higher ground rather than filling the low laying ground (See diagram 5).
- **ATTENTION:** Always remove rocks, stones, sticks, grass roots, and other debris from within the marked pool area.
- Once the pool site is completely leveled, debris removed, and ground smoothed, place a layer of sifted dirt or masonry sand that completely covers the pool site (See diagram 6).
- **NOTE:** If you are using a liner pad or heavy duty tarpaulin (both sold separately) you will not need the sifted dirt or masonry sand in this step.

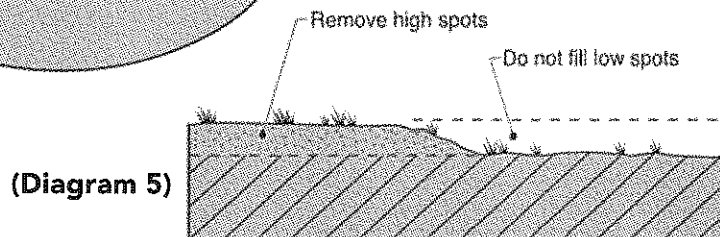
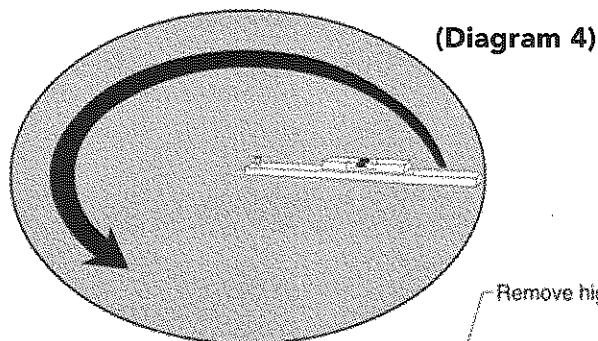

If you are **NOT** using a liner pad, spread a light layer of fine brick layer's sand or sifted dirt over the foundation area. Level this layer carefully.

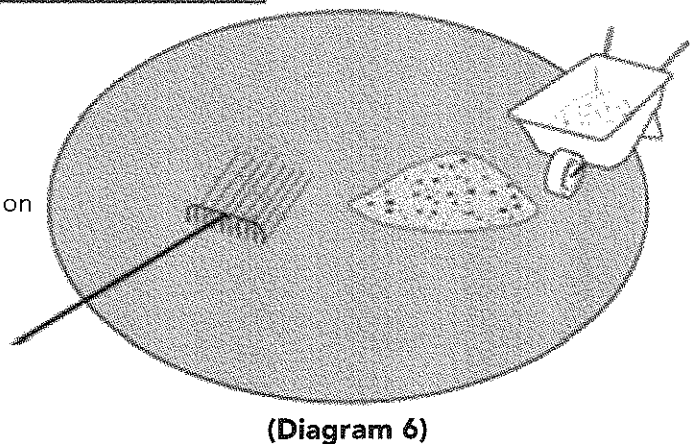

## POOL ASSEMBLY INSTRUCTIONS

Before assembling your product, please take a few minutes to check the contents and become familiar with all the parts.

### WARNING!

**DO NOT** overfill the pool

**DRAIN** the pool to the proper level after a heavy rain.

**TIP:** It will be much easier to install your pool if you unfold it and let it lay in direct sunlight for about 2 hours prior to installation. This will help to ensure a wrinkle-free fit because the pool material will be more pliable allowing it to form into shape during installation.

1. Carefully unfold the pool liner in the area selected and inspect the seams for manufacturing defects.
2. It is recommended to let the pool sit out in direct sunlight for about 2 hours prior to installation (see TIP above).
3. LIFT the pool liner across the ground. DO NOT drag the liner from one location to another location.
4. Locate the pool so that the pump opening is within the length of the electrical cord of the GFCI protected electrical outlet.

## POOL LADDER ASSEMBLY

- Follow the assembly instructions that came with the ladder for your pool. Assembling the ladder now will allow you to use it for access into and out of the pool during the liner installation process.

## POOL ASSEMBLY INSTRUCTIONS (CONTINUED)

**NOTE!** Depending on the size of your pool, there will be different quantities of the frame components. The diagrams below are for visual reference only.

6. Insert the Vertical Legs (3) into the Leg Caps (5)

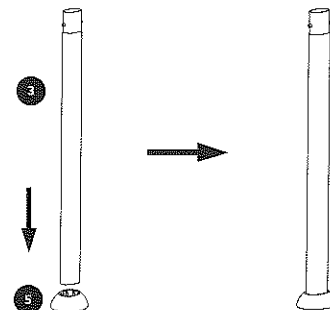

7. Lay all the parts on the ground as shown below.

**CAUTION!** Position the liner with the openings for the pump's water connections facing the electrical outlet.

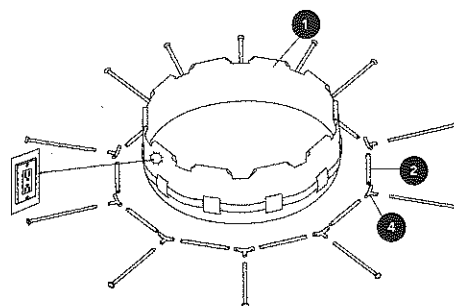

\*Image for reference only.

## POOL ASSEMBLY INSTRUCTIONS (CONTINUED)

8. Carefully slide the Horizontal Beams (2) into the sleeves of the pool.

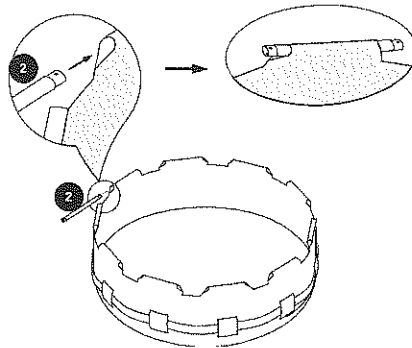

9. Connect the T-Fitting (4) to the Horizontal Beam (2).

**IMPORTANT:** The last T-Fitting (4) can be difficult to connect. Connect the first side of the Horizontal Beam to the T-Fitting. Then, angle the second side of the T-Fitting up slightly and begin to push the Horizontal Beam into the T-Fitting. Finish sliding the Horizontal Beam into the T-Fitting and ensure it is secure.

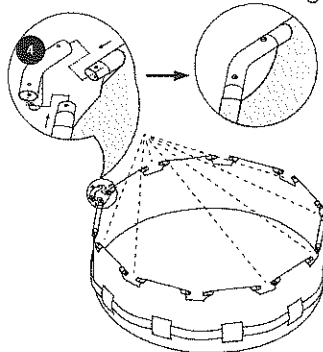

10. Insert the Pins (6) down through the top of the T-Fittings until the Pins snap into place on the lower side of the T-fitting.

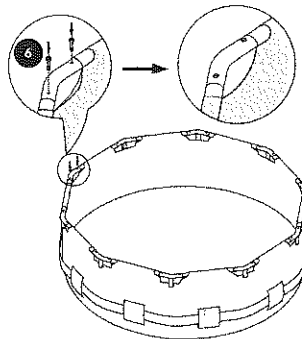

11. Carefully slide the Vertical Legs (3) up through the belt that runs around the pool. **TIP:** For smaller pools without a belt, slide the vertical legs up through the sleeves on the pool wall.

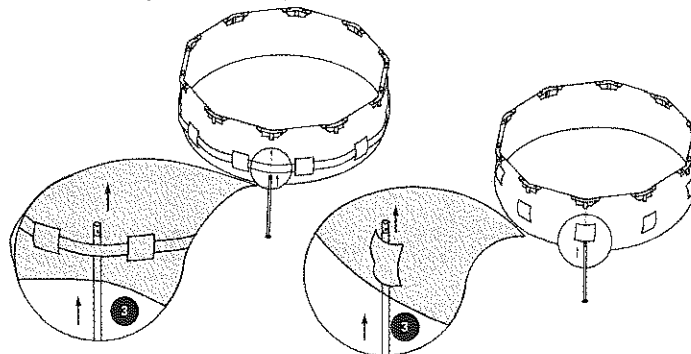

## POOL ASSEMBLY INSTRUCTIONS (CONTINUED)

12. **FOR 15' & 18' ROUND POOLS ONLY!** Look through the hole in the vertical leg of the T-Fitting as you insert the Vertical Leg. Rotate the leg until the holes in the Vertical Leg and the T-Fitting align. **TIP:** A Philips screwdriver can be helpful in aligning the holes. Insert the pins through the holes until they snap into place. Continue until all Vertical Legs are connected and pinned to the T-Fittings.

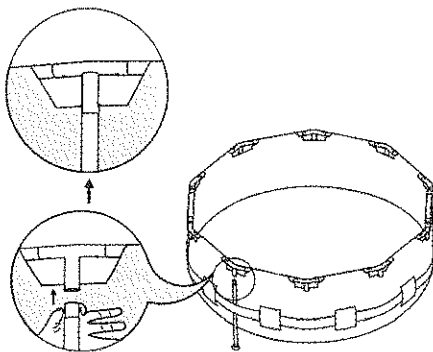

13. Go around and check all fittings, legs, and beams are properly installed and secured in place. Make sure the drain fitting is plugged securely and the cap is in place.

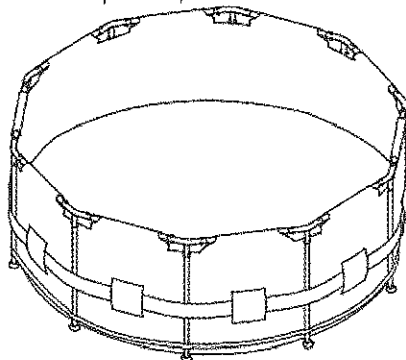

14. Fill up the pool with about an inch (1") [2.54cm] of water. Stop filling and smooth out all wrinkles from the pool floor, working outwards from the center, so that it fills evenly.
- Note:** If more than one to two inches (1"-2") [2.54cm-5.08cm] of water collects on any one side before the pool starts filling in the center, the pool is not level enough, and must be corrected.
15. Before adding additional water you must install the thru-wall water intake and returns fittings and connect the filtration system as per the filtration system instruction manual.
16. Once you have completed the assembly and attachment of the filtration system you can continue to fill the pool. Add water to a minimum of six inches (6") [15.24cm] below the top rim.

**NOT FOLLOWING THE STEPS ABOVE WILL MAKE THE POOL FILL UNEVENLY. THE POOL MAY LEAN TO ONE SIDE AND COLLAPSE. THE VERTICAL LEGS MUST BE STRAIGHT AND VERTICAL TO THE GROUND. IF YOUR POOL IS LEANING, THE GROUND MAY NOT BE LEVEL AND YOU WILL NEED TO START OVER.**

**DANGER! FAILURE TO FOLLOW THE GROUND PREPARATION AND ASSEMBLY INSTRUCTIONS ABOVE WILL CAUSE YOUR POOL TO COLLAPSE, POSSIBLY CAUSING FLOODING DAMAGE OR INJURY TO SWIMMERS. A POOL THAT COLLAPSES DUE TO NOT BEING LEVEL WILL VOID THE WARRANTY.**

## FILTRATION SYSTEM, WATER INTAKE, AND RETURN FITTING INSTALLATION

**IMPORTANT:** BEFORE ADDING WATER TO YOUR POOL YOU MUST INSTALL THE POOL WALL FITTINGS OR ENTIRE FILTRATION SYSTEM FIRST. BEFORE ADDING ADDITIONAL WATER TO YOUR POOL FOLLOW THE INSTRUCTIONS IN THE FILTER MANUAL THAT CAME WITH YOUR FILTER SYSTEM.

ALL WATER INTAKE AND RETURN DIAGRAMS WILL BE DETAILED OUT IN THE FILTER MANUAL. THIS WAS PROVIDED IN YOUR POOL PACKAGE.

## FILLING THE POOL WITH WATER

- Before completely filling the pool with water, thoroughly check to see if there are any leaks in the liner, filter systems, hoses, water intake, return fittings, or the drain assembly.
- Fill the pool until the water is a minimum of 6-in (15-cm) from the top of the pool wall (see diagram 7). This will ensure the water is entering the intake fitting and flowing into the filter system.

**WARNING!** To avoid pool wall collapse, never leave the pool empty without water! The warranty does not cover damage to an empty pool.

**WARNING!** The filter pump must be switched off whenever there are swimmers inside the pool.

**WARNING!** Do not overfill the pool or allow people to lay over or sit on the pool frame. **DOING SO CAN CAUSE THE WALL TO COLLAPSE CAUSING PROPERTY DAMAGE OR SERIOUS INJURY.**

Make sure the pools waterline is at least 6-in (15-cm) below the top of the pool wall.

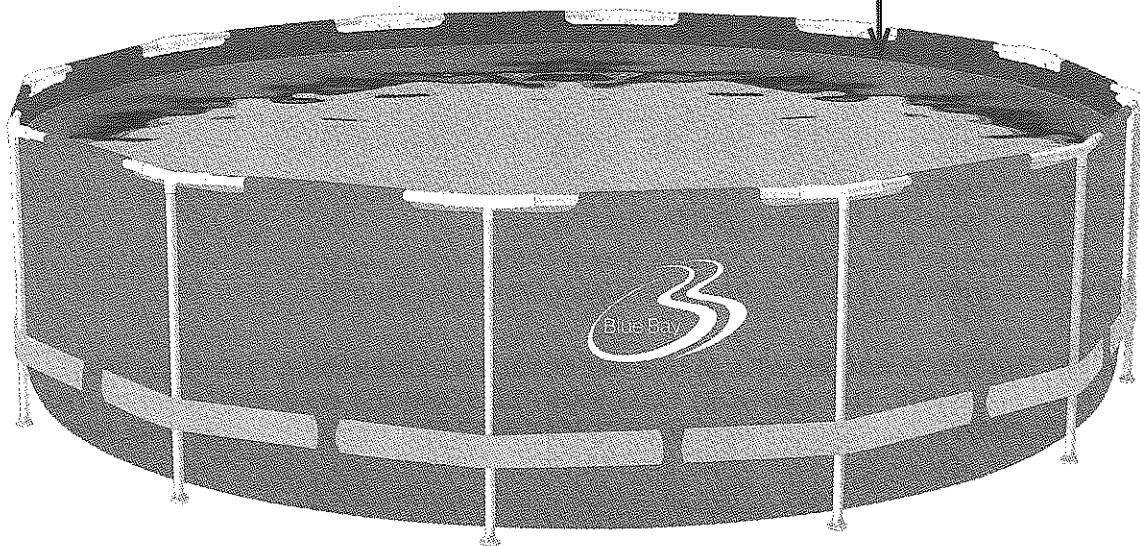

(Diagram 7)

# SAFETY WARNINGS

- The two following safety warning decals are printed on your pool wall. See the below images for reference. These are pre-installed on your pool.

## WARNING DECALS

<b>⚠ WARNING</b>		
<b>PREVENT DROWNING!</b> Closely watch children who are in or near this pool. Children under 5 are at the highest risk for drowning. Prevent access when the pool is not in use.	<b>NO DIVING!</b> Death or permanent injuries such as paralysis may occur.	<b>PREVENT DROWNING!</b> Avoid playing or swimming by all drains and suction fittings. Body parts, hair, or jewelry may be trapped, causing permanent injury or drowning. Do not use the pool if the drain or suction covers are missing or broken.
<b>PREVENIR AHOGAMIENTO!</b> Vigile de cerca a los niños menores de 5 años cuando el mayor riesgo de ahogarse. Evite el acceso cuando la piscina no esté en uso.	<b>NO BUCEAR!</b> Puede producirse la muerte o lesiones permanentes como parálisis.	<b>PREVENIR AHOGAMIENTO!</b> Evite jugar o nadar junto a todos los desagües y accesorios de succión. Las partes del cuerpo, el cabello o las joyas pueden quedar atrapadas y causar lesiones permanentes o ahogamiento. No utilice la piscina si faltan o están rotos las tapas de drenaje o de succión.
<b>PRÉVENEZ LES NOYADES !</b> Surveillez attentivement les enfants qui se trouvent dans cette piscine ou à proximité. Les enfants de moins de 5 ans sont les plus exposés au risque de noyade. Empêchez l'accès lorsque la piscine n'est pas utilisée.	<b>PAS DE PLONGEON !</b> Risque de décès ou de blessures permanentes telles que la paralysie.	<b>PRÉVENEZ LES NOYADES !</b> Évitez de jouer ou de nager près des drains et raccords d'aspiration. Des parties du corps, des cheveux ou des bijoux peuvent être piégés et entraîner des blessures permanentes ou la noyade. N'utilisez pas la piscine si les couvercles de drains ou d'aspiration sont manquants ou cassés.

### DANGER:

- COMPETENT SUPERVISION AND KNOWLEDGE OF THE SAFETY REQUIREMENTS IS THE ONLY WAY TO PREVENT DROWNING OR PERMANENT INJURY IN THE USE OF THIS PRODUCT! NEVER LEAVE YOUNG CHILDREN UNATTENDED.
- POOL FENCING LAWS AFFECT THIS PRODUCT, CONSULT YOUR LOCAL CODES AND ORDINANCES.
- ADULT ASSEMBLY AND DISASSEMBLY REQUIRED.
- DO NOT ALLOW ANYONE TO SIT ON OR STRADDLE THE SIDES OF THE POOL.

### PELIGRO:

- EL CONOCIMIENTO DE LOS REQUERIMIENTOS DE SEGURIDAD Y LA DEBIDA SUPERVISION SON EL ÚNICO CAMINO PARA PREVENIR AHOGAMIENTO O LESIONES PERMANENTES CON EL USO DE ESTE PRODUCTO! NUNCA DEJE NIÑOS PEQUEÑOS DESATENDIDOS. LAS LEYES SOBRE CERCAS PARA ALBERCAS AFECTAN A ESTE PRODUCTO, CONSULTE A SUS CÓDIGOS Y ORDENANZAS LOCALES. SE REQUIERE MONTAJE Y DESMONTAJE PARA ADULTOS.
- NO PERMITA QUE NADIE SE SIENTE O PERMANezca EN LOS COSTADOS DE LA ALBERCA.

### DANGER:

- UNE SUPERVISION COMPÉTENTE ET LA CONNAISSANCE DES EXIGENCES DE SÉCURITÉ EST LE SEUL MOYEN DE PRÉVENIR LES NOYADES OU LES BLESSURES PERMANENTES DURANT L'USAGE DE CE PRODUIT. NE JAMAIS LAISSER LES ENFANTS SANS SURVEILLANCE.
- LES LOIS SUR LES CLÔTURES DE PISCINE AFFECTENT CE PRODUIT, CONSULTEZ VOS CODES ET ORDONNANCES LOCAUX.
- MONTAGE ET DÉMONTAGE POUR ADULTES REQUIS.
- INTERDIRE À TOUTES PERSONNES DE S'ASSOÏRER OU DE CHEVAUCHER SUR LES PAROIS.

### POOL DRAINAGE / VACIADO DE LA PISCINA / VIDANGE DE LA PISCINE

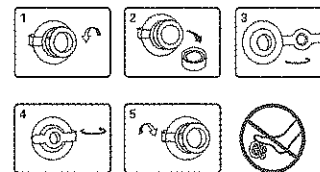

## WARNING SIGNS

WARNING SIGN (A): Should be installed in an obvious location that can be seen from the house or the closest gate to the pool.

CPR SIGN (B):

It should be easily seen from the house or the closest gate to the pool.

(A)

<b>⚠ WARNING:</b>		
<b>PREVENT DROWNING!</b> Closely watch children who are in or near this pool. Children under 5 are at the highest risk for drowning. Prevent access when the pool is not in use.	<b>NO DIVING!</b> Death or permanent injuries such as paralysis may occur.	<b>STAY AWAY FROM DRAINS &amp; SUCTION FITTINGS!</b> Avoid playing or swimming by all drains and suction fittings. Body parts, hair, or jewelry may be trapped, causing permanent injury or drowning. Do not use the pool if the drain or suction covers are missing or broken.
<b>PREVENIR AHOGAMIENTO!</b> Vigile de cerca a los niños menores de 5 años cuando el mayor riesgo de ahogarse. Evite el acceso cuando la piscina no esté en uso.	<b>NO BUCEAR!</b> Puede producirse la muerte o lesiones permanentes como parálisis.	<b>¡MANTÉNGASE ALEJADO DE LOS DESAGÜES Y ACCESORIOS DE SUCCIÓN!</b> Evite jugar o nadar junto a todos los desagües y accesorios de succión. Las partes del cuerpo, el cabello o las joyas pueden quedar atrapadas y causar lesiones permanentes o ahogamiento. No utilice la piscina si faltan o están rotos las tapas de drenaje o de succión.
<b>PRÉVENEZ LES NOYADES !</b> Surveillez attentivement les enfants qui se trouvent dans cette piscine ou à proximité. Les enfants de moins de 5 ans sont les plus exposés au risque de noyade. Empêchez l'accès lorsque la piscine n'est pas utilisée.	<b>PAS DE PLONGEON !</b> Risque de décès ou de blessures permanentes telles que la paralysie.	<b>RESTEZ À L'ÉCART DES DRAINS ET RACCORDS D'ASPIRATION!</b> Évitez de jouer ou de nager près des drains et raccords d'aspiration. Des parties du corps, des cheveux ou des bijoux peuvent être piégés et entraîner des blessures permanentes ou la noyade. N'utilisez pas la piscine si les couvercles de drains ou d'aspiration sont manquants ou cassés.

(B)

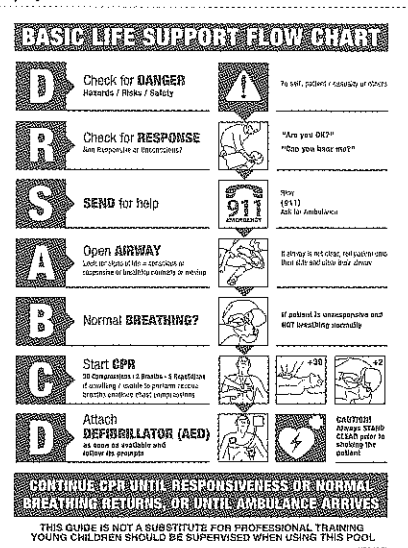

### PLEASE NOTE:

THESE WARNING SIGNS ARE NOT TO BE COVERED UNDER ANY CIRCUMSTANCES!

ALL LADDERS HAVE WARNING DECALS. THESE MUST BE INSTALLED PER THE MANUFACTURER'S INSTRUCTIONS.

# POOL MAINTENANCE & DRAINING

1. Keep the pool clean and maintain proper water chemistry by applying the correct pool chemicals. Unsanitary water is a serious health hazard.
2. Maintain pool pH level between 7.2 to 7.6.
3. Carefully follow the installation and other instructions in the filtration system manual.
4. Clean the liner regularly with non-abrasive brushes or an approved vacuum system.
5. If the pool liner is scratched, drain the pool, clean the scratched surface and keep it dry, put the adhesive repair patch on the scratched area and press it tightly. Wait one hour before using the pool. The laminated vinyl patch can also be used for repairing, please note that the glue (not included) should be applied evenly on the laminated vinyl patch. Put the laminated vinyl patch on damaged area and press it tightly. Wait 24 hours for drying before using the pool.

**NOTE:** For additional information on the assembly and use instructions for the Jet Vacuum Maintenance Kit, see the manual that was included with your pool package.

6. Run filtration system at least one full day before using the pool. Allow enough time to ensure the pool water is completely filtered and sanitized before swimming.

## HOW TO DRAIN YOUR POOL AND LONG-TERM STORAGE

1. Check local regulations for specific directions regarding disposal of swimming pool water.
2. Pull the clear plastic plug from the drain fitting inside the pool or attach the drain connector from the outside of the pool. The drain connector will push out the clear plastic drain plug so you do not have to dive to the bottom of the pool. You can then attach a garden hose to the drain connector to direct the water flow to your desired location.
3. Once the water stops draining, lift the pool from the side opposite to the drain valve. This will drain any remaining water and empty the pool completely.
4. Remove all connecting thru-wall water intake and return fitting parts.
5. Remove, drain, and dry the filter system for storage. Remove the aqualoon from the filter tank. Clean it, dry it, and store per instructions in the filter manual.
6. Disassemble the frame parts in the **REVERSE** order of the assembly instructions.

## LINER FOLDING INSTRUCTIONS & STORAGE.

7. Be sure that the pool and all parts are completely dry before storage. Air dry the liner in the sun until it is completely dry before folding (see drawing 1). Sprinkle some talcum powder to prevent the vinyl from sticking together and to absorb any residual moisture.
8. Create a square shape. Starting at one side, fold one-sixth of liner into itself twice. Do the same on the opposite side (see drawings 2 & 3).
9. Once you have created two opposing folded sides, simply fold one over the other like closing a book (see drawings 4 & 5).
10. Fold the two long ends to the middle (see drawing 6).
11. Fold one over the other like closing a book, and finally compact the liner (see drawing 7).
12. Store the liner and accessories in a dry, temperature-controlled storage location above 32°F (0°C) and below 104°F (40°C).
13. The original packaging can be used for storage.

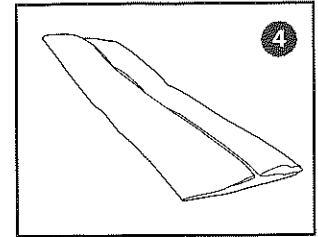
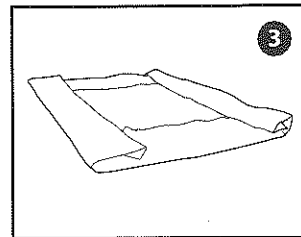
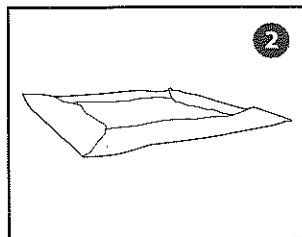
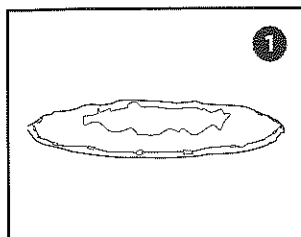

**ATTENTION:** See the next page for Diagrams 5, 6 and 7 of the liner folding instructions.



## POOL MAINTENANCE & DRAINING (CONTINUED)

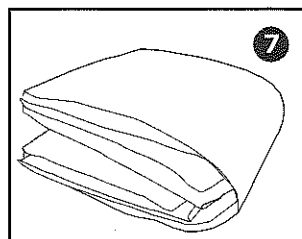
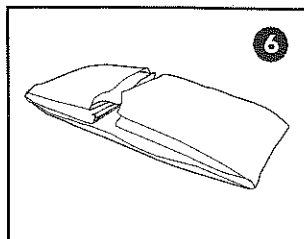
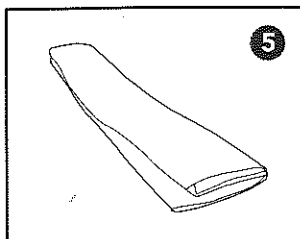

## JET VAC MAINTENANCE KIT

- Please follow the assembly and use instructions that came with the maintenance kit in your pool package.

## POOL STORAGE & WINTERIZATION

**WARNING:** This above-ground pool cannot be winterized. If you live in an area where the temperature drops below 32°F (0°C), your pool must be drained, disassembled, and stored properly. If you are in a warmer environment, please follow the winterizing instructions below.

After seasonal use, you can easily drain and store your pool in a safe and dry location. However, in warmer climates, some pool owners choose to leave their pool up all year round. If this applies to you, see the directions below. If you live in colder areas, where freezing temperatures occur, there is a high risk of ice damage to your pool. Therefore, leaving your above-ground pool set up in areas where the temperature drops below 32 degrees Fahrenheit (0°C) will void the pool warranty.

### How to Winterize Your Pool

1. Begin by cleaning the pool water thoroughly and adjust the water chemistry as needed.
2. Remove the water intake and return fittings from the inside of the pool (if applicable).
3. Now, remove the ladder (if applicable) and store in a safe place. Ensure the ladder is dry before storage.
4. Remove the hoses that connect the pump and filter to the pool.
5. Add the appropriate chemicals for the winter period. Consult your local pool dealer as to which chemicals you should use and how to use them. **NOTE:** These may vary greatly by region.
6. Cover pool with a Pool Cover. **IMPORTANT: pool cover is not a safety cover.**
7. Clean and drain the pump, filter housing, and hoses. See instructions for winterizing the aqualoon balls in your filter manual.
8. Bring pump and filter parts indoors and store in a safe and dry area, preferably between 0°C (32°F) and 40°C (104°F).

## POOL COVER USE & SAFETY

If you are going to use a pool cover, solar cover, or solar blanket, please read the following information.

### POOL COVER, SOLAR COVER, & SOLAR BLANKET WARNINGS

#### **WARNING!** AVOID DROWNING RISK.

**WARNING:** Non-secured or improperly secured covers are a hazard.

**WARNING:** Only use the included drawstring to secure the cover to the pool.

**WARNING:** Labels must be facing up when the cover is installed.

**WARNING:** Keep children and small animals away from the covered pool.

**WARNING:** Remove standing water from the top of the cover to avoid drowning.

**WARNING:** Remove the cover completely before swimming to avoid entrapment.

**WARNING:** Stay off the cover. It is not designed to hold any weight.

**WARNING:** This is not a safety cover.

**ATTENTION:** Type OC cover classification.

**ATTENTION:** This cover meets requirements described in specification F-1346 (ASTM)

**WARNING:** Failure to follow all instructions may result in injury or drowning.

#### **IMPORTANT!**

DO NOT use a pool cover, solar cover, or solar blanket on this pool if it does not have the correct type of warning label on the cover.

#### **DANGER!**

Competent supervision and knowledge of the safety requirements are the only ways to prevent drowning or permanent injury in the use of this product!

#### **WARNING!**

Never leave young children unattended in or near the pool!

## FRAME POOL WARRANTY

Warranties are in separate leaflets.